

Technical Design Report of *Nala Proteus 2.0*: An Autonomous Surface Vessel by Barunastra ITS Roboboat Team

Abdillah M, Afrina R, Arieq M, Bahri Z, Christanto S, Dananjaya I, Darmawan I, Dewi T, Dhiyya'ul-Haq I, Dikairono R, Fadh M, Farchan M, Firmansyah M, Firmansyah R, Frizzy J, Ghifari A, Hakim M, Hikmawati A, Kosasih F, Mohamad I, Muhtadin, Musyaffa A, Nurhasan A, Pattinasarany F, Prameswari I, Prayoga A, Risqi M, Romadlon M, Samawi T, Setyawan B, Thaariq M, Wibisono D,
Institut Teknologi Sepuluh Nopember
Surabaya, Indonesia
barunastra.its@gmail.com

Abstract—Barunastra ITS Roboboat Team upgraded the *Nala Proteus* ASV for Roboboat 2024, increasing its reliability, rigidity, and level of integration between components. This is done to attempt to complete all missions and is achieved through frame height increase, the addition of several new components, adjustments in the water blaster system, a more watertight and breathable electrical & control box, and an articulated camera. Furthermore, upgrades in internal communication and emergency countermeasure systems are implemented along with upgrades in real-time kinematics and ground control communication. Alongside that, a significant change in software architecture is implemented, allowing for a wider range of sensors to be used. A behavior-tree-based mission manager system is used alongside a bespoke web user interface. By executing thorough tests on components of the system, *Nala Proteus 2.0* completes the pre-qualification requirements for Roboboat 2024, gaining a competitive advantage for this year's regatta.

Keywords—Ease-of-use, Integration, Maintainability, Reliability, Safety

I. COMPETITION STRATEGY

A. General Strategy

In light of *Nala Proteus*' performance at Roboboat 2023 [1], Barunastra ITS shifted its strategy for Roboboat 2024—prioritizing the ASV's reliability and ease of use. New criteria were added to the ASV design and development process to fit the new strategy. This is done to ensure consistently great performance in points gathered during autonomous missions, even in challenging situations.

To fulfill the goals of the strategic shift, Barunastra ITS adopted the following criteria:

- 1) Increase software reliability without hindering ease of use.
- 2) Create a stable and easily maintainable electronics system.
- 3) Increase ASV rigidity and physical strength whilst still maintaining a high level of modularity.
- 4) Maintain a high degree of integration between every system component—mechanical apparatus, electrical components, and software programs.

B. Course Approach

Based on the general strategy aforementioned in the previous subsection, a set of parameters is used as heuristics for determining the priority of tasks during this year's autonomous missions:

- 1) Points gathered on Roboboat 2023 for the specific mission—more is better.
- 2) Amount of man-hours needed to develop and test ASV's ability to complete the mission—less is better.
- 3) Types of sensors being used—more is better.
- 4) Significance of waypoint navigation towards completing the mission—less is better.
- 5) Component susceptibility to damages caused by system failures that may appear during the mission—less is better.
- 6) Hours invested and experience in executing the mission or its variant during previous competitions—more is better.

Barunastra ITS decided to attempt to complete every mission on Roboboat 2024 [2], focusing on optimizing for the following missions, by priority: Navigation Channel, Follow The Path, Speed Challenge, Docking, and Duck Wash. Barunastra ITS also plans to attempt the Collection Octagon and Delivery Octagon mission by implementing a rudimentary upgrade, designed to complete the new missions without disturbing the performance of other missions.

Multiple types of sensors are used in missions to serve as redundancy, ensuring generally consistent operation even during malfunctions. Barunastra ITS avoids the use of waypoint navigation in light of possible arena permutability—a major setback for performance in Roboboat 2023. An upgrade in electrical, mechanical, sensors, and software components is implemented to ensure higher and more consistent 1st percentile performance during autonomous challenges.

C. Task Execution

1) *Gate Navigation Task*: Navigation Channel, Follow The Path, Speed Challenge, and Return to Home are all variations of gate navigation tasks. These tasks require the ASV to rely upon its computer vision systems to find the proximity and angle of detected gates and or buoys. This year, the use of LiDAR and Depth-sensing Cameras will aid in eliminating problems related to buoy or gate proximity and location, as well as making the ASV able to detect objects better than a conventional camera.

2) *Docking Task*: Every mission other than that listed as Gate Navigation Tasks is a variation of docking. Docking tasks require the ASV to be able to detect and dock into given platforms. LiDAR and Depth-sensing cameras are used to map the location and orient the ASV. The ASV will then dock into the given platform whilst maintaining correct orientation, ensuring that the main camera is constantly able to help locate the platform and center the ASV.

3) *Station-keeping Task*: The ability to actively maintain position is crucial for object delivery and water blasting tasks, which require the ASV to be stable at all times. The location and orientation of the ASV from the station-keeping target will be constantly monitored and stored, enabling the ASV to execute error corrections using the data from the Inertial Navigation System (INS).

4) *Object Delivery Task*: The Collection and Delivery Octagon are the only tasks that constitute Object Delivery Tasks. The ASV needs to collect an object and deliver it to the specified location. A camera-mounted crane is installed, which allows for the ASV to accurately orient the crane to the object. The collected objects will be placed inside a basket, which will then be emptied into an arena. Considering the limited time of development for Roboat 2024, Barunastra ITS will only focus on the collection and delivery of the objects—sorting of the objects will be disregarded.

5) *Mission Transition*: In Roboat 2023, Nala Proteus only relied upon waypoints to navigate from one mission to another. This year, an algorithm that utilizes a Depth-sensing camera and LiDAR is implemented to navigate the ASV in between two missions. The ASV will identify mission areas that exist in its proximity and use a predefined set of heuristics to determine what mission area it should navigate to after finishing a mission. See Appendix A for the flowchart of the algorithm.

II. DESIGN STRATEGY

A. Mechanical Subsystems

1) *ASV Design*: In light of the conditions faced during Roboat 2023, a height increase is added to the frame to minimize water spills into the deck, which significantly increases the safety of electrical components. A hinge profile and a set of hinge plates are installed to increase the rigidity of the frame.

Side rollers are also added to this year's iteration of Nala Proteus, designed to prevent the ASV from colliding with

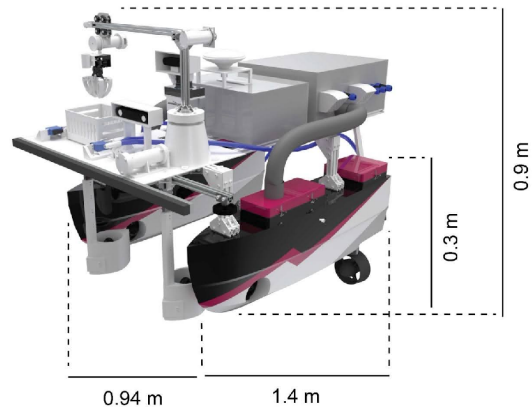

Fig. 1. Nala Proteus 2.0 design details

arena boundaries during docking missions. The side rollers can also move and correct the ASV's orientation, should it collide with walls/side boundaries.

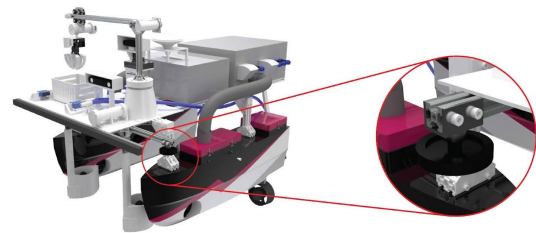

Fig. 2. Side Rollers Design

2) *Heave Thruster*: Our assessment indicates that the frontal load on the vessel tends to be heavier during the execution of the 'collection octagon' and 'delivery octagon' missions. As such, this year's iteration of Nala Proteus will introduce a heave thruster system, comprising two thrusters positioned at the ship's bow. This system is designed to optimize the vessel's positional control during such missions.



Fig. 3. Heave thruster design

The thruster system will automatically counter excessive pitch encountered during acceleration and braking. To minimize drag increase and maintain adequate fluid dynamics, Barunastra ITS has designed a NACA-airfoil-esque-shaped cover for the thruster [3].

3) *Object Collection Mechanism*: To complete the collection octagon mission, we implemented a crane object collec-

tion system. This system is used considering the overall higher levels of safety when using cranes compared to other types of systems, such as using a scooper—which is prone to being stuck in the arena.

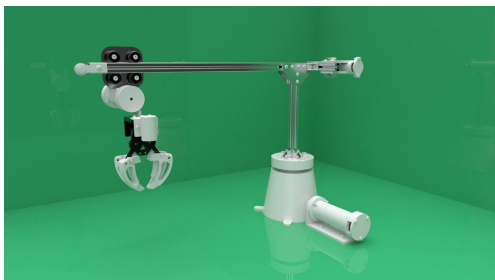

Fig. 4. Crane Object Collection Mechanism

The crane consists of three brushed motors equipped with embedded incremental encoders, which allows for a high level of precision. Additionally, a clamping mechanism in the form of a powerful yet lightweight servo motor is affixed at the crane's terminus. A camera is also mounted on the clamp of the crane, increasing accuracy in the collection octagon mission.

4) *Water Blast System*: This year's iteration of Nala Proteus utilizes computer vision and odometry to calculate when and where to blast water. The water blast system utilized in this iteration is less complex. The blaster's angle of attack is only adjustable during maintenance. This consideration is implemented due to the larger target area compared to similar missions in RoboBoat 2023.



Fig. 5. Nala Proteus 2.0 Water Blast System

5) *Box and Cooling System*: Two IP67-rated boxes are used each as electrical and control boxes in this year's iteration. Temperature sensors and the ability to control fan speed are also installed to increase power efficiency.

Due to control components being extremely sensitive to water damage, the control box needs to be significantly more resistant to water leaks. As such, the control box is equipped with an HVAC system to regulate temperature, by installing air ventilation shafts connected to 2 fans attached to the electrical box, eliminating the need to directly mount fans on the control box.

6) *Articulated Camera*: This year features an upgrade in our camera's resolution from 1080p to 4K for clearer images. This is also motivated by the amount of wear-and-tear of our

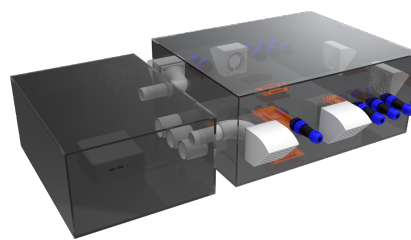

Fig. 6. Electrical and Control Box Design

previous camera. A hood is created for this iteration to prevent further damage to the new camera from heat and rain.

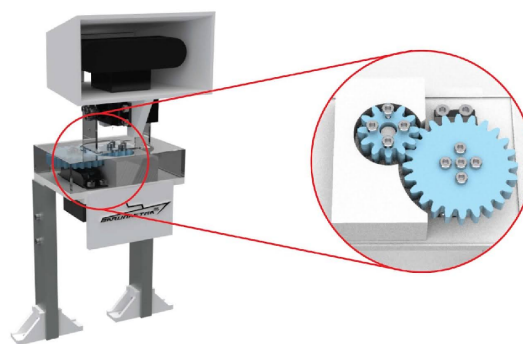

Fig. 7. Articulated Camera Design

Furthermore, the camera is equipped with two servos, allowing the camera to rotate along both y and z-axes. The camera cover is placed with a wide clearance, ensuring the camera's ability to rotate with a wide angle of motion along the y-axis. The yaw servo utilizes a 1:2 gear system, enabling the camera to rotate freely along the z-axis as well as reducing the load on the servo [4]. This apparatus allows the ASV to 'look around' and find the next mission, should it not be able to see anything using the camera's current orientation.

B. Electrical Subsystems

1) *Independent Supply Cut-off and LCD Monitoring*: During trials, Nala Proteus experienced lagging on both computers and microcontrollers. This leads to an inability to stop the ASV since the emergency stopping mechanism is connected to the main microcontroller. Hence, we decided to add an independent emergency stop controller to prevent such an issue from happening in the future. Additionally, we also implemented further monitoring systems, allowing access to the data through the ASV's screen and wireless emergency stop, in addition to our ground computers.

2) *CAN Bus Communication*: This year, we moved from serial communication which had a speed of 100Kbps to CAN Bus which had a speed of 1Mbps so that data transfer speed increased drastically. CAN Bus also makes us easier to wiring because we can connect multiple devices in one can bus. Here we use CAN Bus to monitor over six ESCs such as voltage, current, temperature, and more.

3) *Long Range Emergency Switch*: The 915 Mhz frequency used last year is more susceptible to interference such as water waves and ground objects that act as physical obstructions and other noises that may be picked up by the radio signal. This year's LoRa kill switch will use a 433 Mhz frequency band to minimize such issues. The emergency kill-switch system is also equipped with an LCD monitoring system.

4) *RTK*: Nala Proteus' performance during Roboat 2023 indicated that the accuracy of standard GPS modules is not sufficient to meet the strict navigation criteria. Factors such as signal interference and changes in atmospheric conditions contribute to significant noise in positional data given by the GPS module. This year's iteration of Nala Proteus integrated Real-time Kinematics (RTK) into the localization algorithm of the ASV to counter this issue.

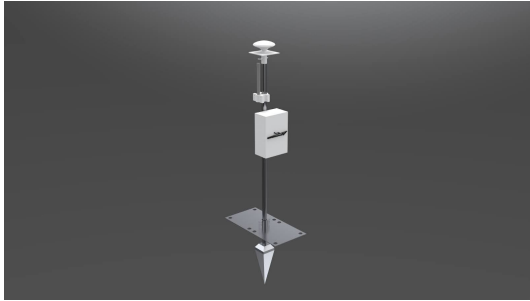

Fig. 8. RTK Base Design

During Roboat 2023, the tripod stand underwent severe damage due to heavy winds and impacts from objects. This year's stand is mounted into the ground, minimizing positional changes of the RTK station due to such issues.

5) *Ground Control System*: In light of poor communication reliability during Roboat 2023, a Ubiquiti transceiver is utilized to ensure a consistent connection between the ASV and GCS. Barunastra ITS configured the transceiver to have good signal strength and a very large data transfer bandwidth.

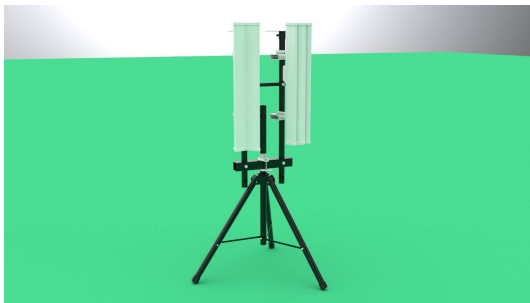

Fig. 9. Ubiquiti Transceiver

The GCS will be equipped with a sectoral antenna for higher signal strength with the cost of a limited angular range. Thus, the orientation of the antenna needs to be adjusted to point to the desired direction. Despite the limited communication range, the ASV will be equipped with an omnidirectional antenna to ensure connection regardless of orientation.

C. Software Subsystems

1) *Computer Vision*: Barunastra ITS has found that last year's main computer used CPU-based inference, which hinders the ASV's control program and adjustments to increasingly varied competition missions. NVIDIA Jetson AGX Orin is used for Nala Proteus 2.0 to counter these problems, which allows the team to shift to optimize the vision framework using OpenVINO and TensorRT.

We also migrated from YOLOv4-tiny-3l to YOLOv7 for its higher accuracy and easier development [5]. This is also inspired by YOLOv4's difficult development and longer duration during dataset training. This year, buoy color separation is done through a Support Vector Machine (SVM) implementation called 'ThunderSVM'. This allows for SVM calculation via GPU. Furthermore, A ZED Camera is installed for spatial mapping and 3d splatting, allowing the ASV to sense its environment without needing to rely on the main camera.

2) *Software Architecture*: This year's iteration of Nala Proteus will utilize ROS2, due to ROS1 nearing its end of life [6]. In general, the software architecture can be divided into 4 sub-architectures: Perception, Mission Control, Navigation, and Hardware Interface.

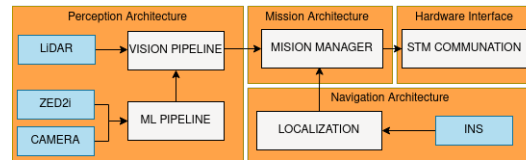

Fig. 10. Software Subsystems Diagram

3) *Control*: This year, Barunastra ITS migrated to using a behavior-tree-based mission manager algorithm, due to its flexibility and ease of maintenance [7]. Using the BehaviorTree.CPP library, the current mission manager outshines traditional Finite State Machine (FSM) mission managers, by being able to rapidly visualize and interpret ASV behaviors. The well-defined linear and transition nodes aids in configuring robot behavior. This is done simply by moving node positions without worrying about uncounted transition states.

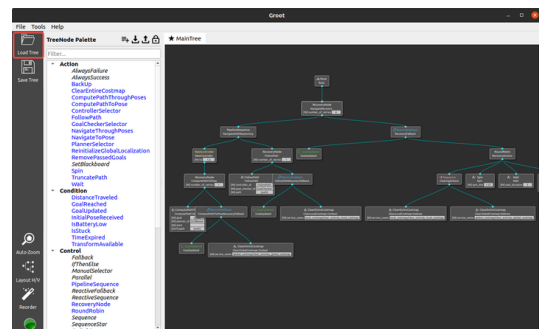

Fig. 11. Behavior-tree-based mission manager

4) *User Interface*: This year Barunastra ITS created a bespoke React web user interface. The custom-made user interface is built to ease technicians in controlling the ASV, through an easy-to-use UI layout that is also pleasing to view.

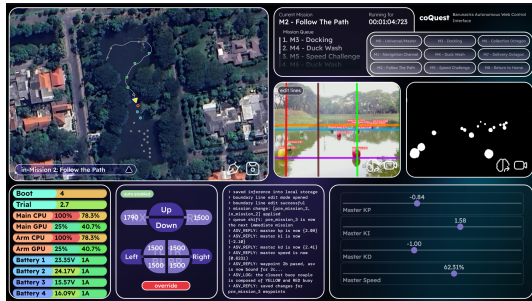

Fig. 12. coQuest, The Custom-made User Interface App for Roboat 2024

The custom-made UI implemented various components, including:

a) *Mission Queue System*: Instead of having to switch between missions manually with their respective pre-mission and in-mission states, the UI technician can instead list the missions in a queue. The pre-mission tasks are done automatically in between two missions. Using the mission priority algorithm, the technician can even let the ASV decide the mission queue by itself.

b) *Responsive Design*: The UI is built upon a custom-made dynamic pixel implementation, which allows for a responsive web UI that focuses on the aspect ratio of the screen instead of the resolution of the display. This year's UI allows the technician to use the UI on a very wide amount of display sizes and aspect ratios, allowing for multiple-window or multiple-device operations to feel much more seamless.

c) *Native Waypoint Navigation*: The UI has waypoint navigation control embedded directly into the web application, which allows for more customized waypoint navigation control.

The custom-made UI will ease the technician in operating and or managing high-level control. Low-level controls, however, will still be done in RViz for this year's iteration.

III. TESTING STRATEGY

A. Water Blast

Acknowledging the change in the water blast mission from Roboat 2023 to Roboat 2024, Barunastra ITS decided to increase the pressure of the water stream to increase range by changing the outlet nozzle diameter [8]. A simulation analysis via ANSYS is conducted to determine the optimum nozzle diameter. Using an inlet water stream speed of 0.534 m/s with a pressure of 101.3263 kPa, a set of data is gathered, which is converted into the table given below.

Using the data gathered from the ANSYS simulations, Barunastra ITS decided to use a water blaster nozzle diameter of 0.5 cm.

TABLE I
OUTPUT NOZZLE STREAM SPEED AND PRESSURE DATA

Diameter (cm)	Stream Speed (m/s)	Pressure (kPa)
0.5	8.743789	39.47823
0.8	3.166116	4.97335
1	1.93472	1.81352

B. Computer Vision

Several YOLOv7 models were compared using an RTX 2060 GPU. This is done to mimic the performance of the NVIDIA Jetson AGX Orin. Comparison results show that YOLOv7-tiny has the best balance of speed and accuracy. This result is caused by the relatively small dataset size.

Weather conditions and battery also affect the inference speed of the computer. As such, both the maximum FPS that can be achieved by the computer and the minimum FPS that may occur during the trial are recorded for consideration.

TABLE II
VISION ML MODEL PERFORMANCE BENCHMARK: FPS

Model	Max. FPS	Min. FPS	Avg. FPS
YOLOv4-Tiny-3l	200.92	23.42	102.82
YOLOv7-tiny	230.65	28.91	199.67
YOLOv7	96.54	60.72	88.63

Considering the performance of each model, Barunastra ITS decided to use YOLOv7-tiny as Nala Proteus 2.0's vision ML model.

C. LiDAR

LiDAR point cloud data is constantly cross-checked with IMU data to ensure the correct orientation of the ASV from the z-axis. The point cloud data is then converted into deep image information using an OpenCV function. Contour detection is then applied to the resulting image to detect the location and orientation of docking platforms.

D. Spatial Mapping and 3D Splatting

Used as redundancy in cases when other visual sensors—such as cameras and or LiDAR sensors—are malfunctioning, a ZED camera's spatial mapping is used as a backup. The spatial mapping and 3D splatting will result in a point cloud data type, which allows for a similar workflow as LiDAR [9]. However, this comes at the cost of very high computational power.

As seen in the figure above, the yellow line represents this iteration's yaw intensity graph, whilst the blue line indicates last year's iteration. This indicates that Nala Proteus 2.0 is

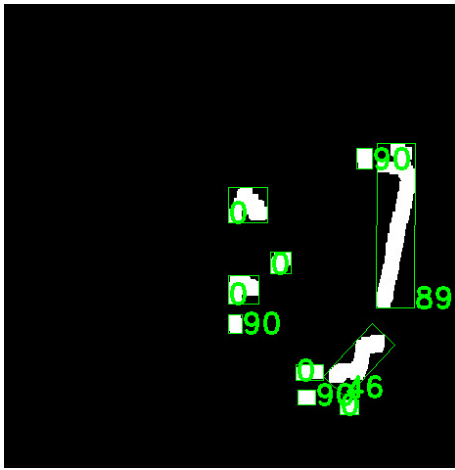

Fig. 13. LiDAR Deep Clustering

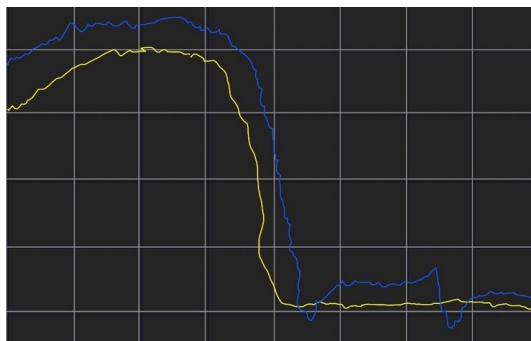

Fig. 14. IMU Comparison

more resistant to yaw-induced instability compared to its previous iteration.

E. ESC Delay

At this time, we replaced the Basic ESC from Blue Robotics to Flipsky VESC. We had some issues with Basic ESC which had a big delay and couldn't break the thruster. We want our ASV to be more responsive so we can maneuver more precisely. The Flipsky ESC that we choose is programmable. This is the Difference between Blue Robotics Basic ESC and Flipsky VESC.

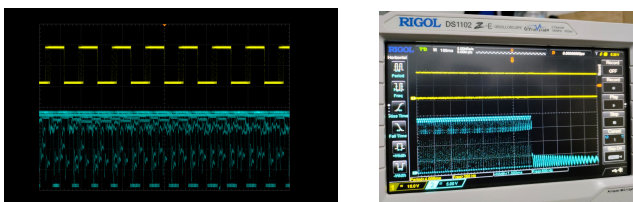

Fig. 15. Comparison between Blue Robotics ESC and Flipsky VESC

From the figures above, the yellow waveform is output from Flipsky VESC and the blue waveform is output from Blue Robotics Basic ESC. The difference is that Flipsky VESC is more stable, responsive, and can break the thruster while Blue

Robotics Basic ESC has an unstable signal, is unresponsive, and thrusters keep spinning while receiving zero thrust.

F. Router Delay

We tested both 2.4 and 5GHz antenna communications, each in 2 different environments: clear and obstructed. We have then found that 5GHz communication persists for at least 200 meters, and 2.4GHz communication persists for at least 700 meters. Barunastra ITS then concluded that 5GHz communication would be used for data links due to its high bandwidth, and 2.4GHz communication would be used for control links due to its wide effective range.

G. Simulation Testing

Extensive simulator testing via Gazebo is used to ensure the proper testing of autonomous systems. Barunastra ITS utilized simulator testing to verify the performance and feasibility of algorithms without having to do in-water testing. Using simulators would also mean being able to test and analyze programs during ship maintenance.

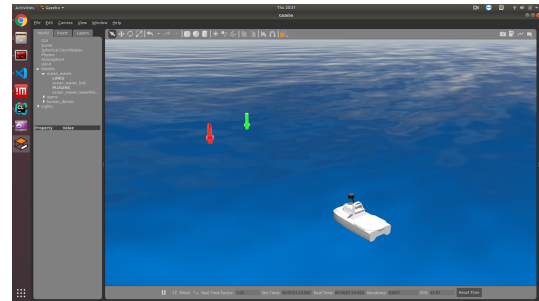

Fig. 16. Mission Simulation via Gazebo

H. In-water Testing

Barunastra ITS also conducted In-water Testing at 'Danau 8', a lake located inside Institut Teknologi Sepuluh Nopember



Fig. 17. In-water Testing Documentation at 'Danau 8'

ACKNOWLEDGMENT

Barunastra ITS would like to thank the support from ITS and the Robotics Club and also encouragement towards the team. The team is incredibly grateful to Mr. Muhtadin, S.T., M.T., Dr. Rudy Dikairono, S.T., M.T., M.Sc., and Mr. Muhammad Lukman Hakim, ST., M.T., Barunastra's advisors, for his

guidance with the team's aspirations and achievements each year.

Additionally, Barunastra ITS would like to thank RoboNation for committing itself to maintaining the International Roboboat Competition and gathering undergraduate students from across the globe to collaborate and compete in a competition dedicated to surface vessel technologies.

REFERENCES

- [1] Januar F, Ramadhan R, Permadani R, "Roboboat 2023: Nala Proteus' Technical Design Report," Barunastra ITS Roboboat Team", Surabaya, 2023
- [2] Robonation Inc., "2024 TEAM HANDBOOK, Version 1," 2023. [Online]. Available: www.roboboat.org
- [3] C. Sarraf and H. Djeridi, "Thickness Effect of NACA foils on hydrodynamic global parameter, boundary layer states and stall establishment," *Journal of Fluids and Structure*, vol. 25, issue 4, 2010.
- [4] R. Fredrik and J. Wikander, "The Influence of Gear Ratio on Performance of Electromechanical Servo System," *IFAC Proceedings Volume*, Volume 39, Issue 16, 2006.
- [5] C.-Y. Wang, A. Bochkovski, and H.-Y. M. Liao, "Wongkinyiu/Yolov7: Implementation of paper - yolov7: Trainable bag-of-freebies sets new state-of-the-art for real-time object detectors," GitHub, <https://github.com/WongKinYiu/yolov7> (accessed Dec. 19, 2023)
- [6] Steven Macenski, Tully Foote, Brian Gerkey, Chris Lalancette, and William Woodall, "Robot operating system 2: Design, architecture, and uses in the wild," *Science Robotics*, 7(66):eabm6074, 2022.
- [7] M. Colledanchise and P. Ögren, "Behavior Trees in Robotics and AI: An Introduction," October 2022.
- [8] D. Nuytens, "Effect of Nozzle type, size, and pressure on spray droplet characteristic," *Journal Biosystem Engineering*, Volume 97, Issue 3, 2007.
- [9] Stereolabs, "Stereolabs/zed-SDK: the spatial perception framework for rapidly building smart robots and spaces," GitHub, <https://github.com/stereolabs/zed-sdk> (accessed Dec. 19, 2023).

APPENDIX A: TASK-FINDING ALGORITHM

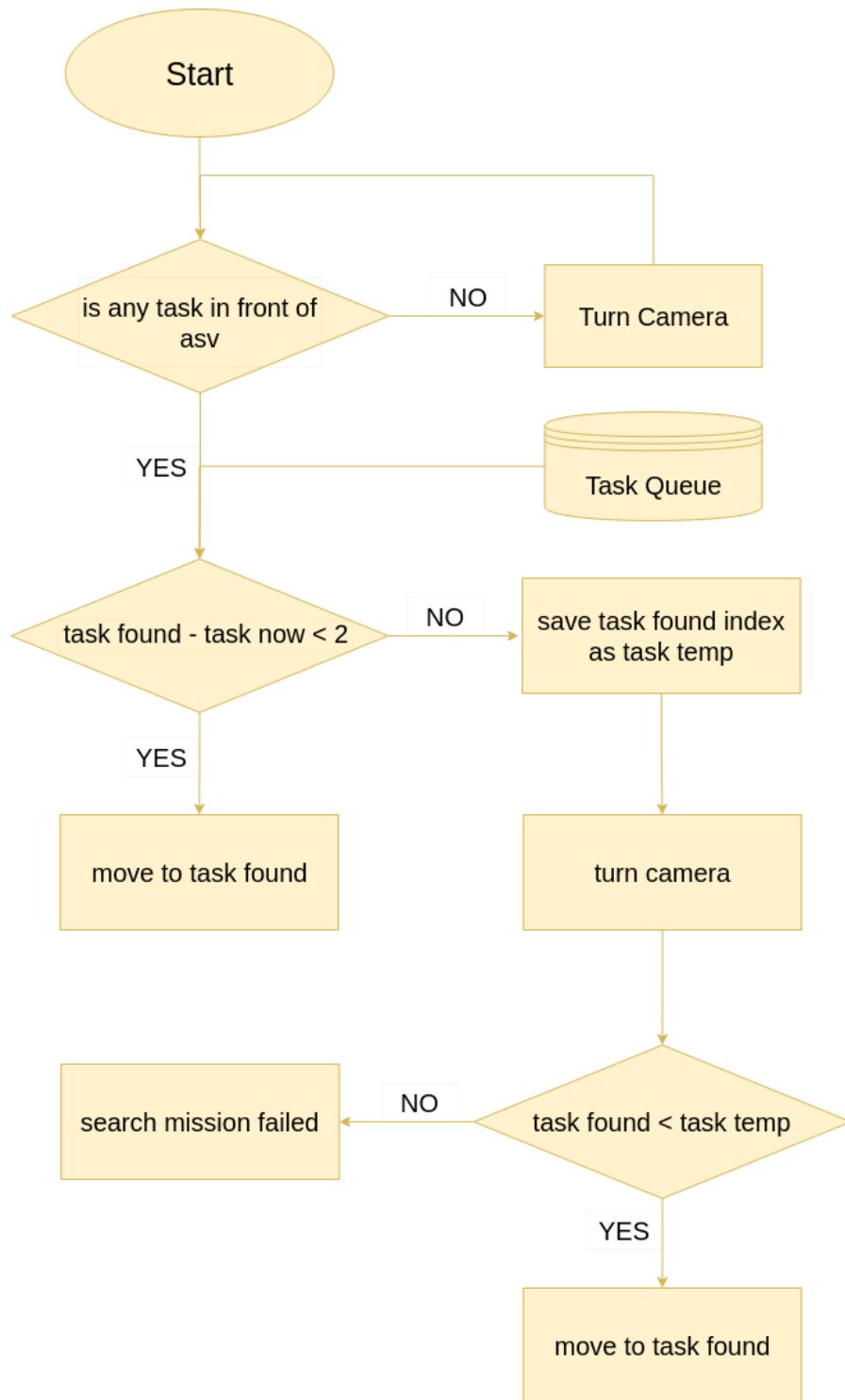

APPENDIX B: COMPONENT SPECIFICATION

Component	Vendor	Model/Type	Specs	Custom/Purchased	Cost	Year of Purchase
ASV Hull	Barunastra ITS	Catamaran Hull	Fiber Glass with LOA = 96.5 cm, Breadth (Hull only) = 20 cm, Height (Hull only) = 29.7 cm. Draft = 18 cm, Displacement = 37.76 kg.	Custom	\$428.00	2022
Platform	Barunastra ITS	V SLOT Extrusion	Aluminium Profile 20 x 20 V SLOT Silver	Custom	\$89.00	2023
Crane	Creality 3D	Extruder Back Support Plate	Extruder Back Support Plate with Pully Ender 3 V2	Purchased	\$8.00	2023
Side Roller	Barunastra ITS	Encoder Wheel	Encoder Wheel (OD) 200 mm	Custom	\$10.00	2023
Small Gear (Camera)	Barunastra ITS	Spur Gear	Nylon Spur Gear (OD) 28mm	Custom	\$10.00	2023
Gear (Camera)	Barunastra ITS	Spur Gear	Nylon Spur Gear (OD) 52mm	Custom	\$11.00	2023
CPU	NVIDIA	Jetson AGX Orin	Power: 15 ~ 60W, GPU : 2048-core NVIDIA Ampere architecture GPU with 64 Tensor Cores	Purchase	\$2806.44	2023
GPS	Sparkfun	ZED F9P	https://www.sparkfun.com/products/17751	Purchase	\$274.95	2022
Camera	Stereolabs	Zed2i stereo camera	https://store.stereolabs.com/products/zed-2i	Donated		2019
LiDAR	Velodyne	LiDAR 16CH	700 (1.54lb) gram package (without lidar) Laser scanner: adapts to Velodyne VLP-16/HDL-32E MEMS IMU: 6DOF solid state i7 dual core processor Input: Power 12-19 vDC Output: USB3 (USB3 to GigE adapter provided)	Borrowed		2023
Compass	Rion-tech	AH100B	High performance drift stability, Wide temperature working: -40 ~ +85°, TTL/RS232 output optional, DC+5V power supply	Borrowed		2013

IMU	Rion-tech	TL740D	Azimuth Angle ($\pm 180^\circ$), >100Hz, <2mm/m (converted from angle accuracy, <0.1°/min	Borrowed		2023
Communication	Ubiquiti	airMAX Omni Antenna AMO-5G10	AMO-5G10 Dimensions 582 x 90 x 65 mm (22.9 x 3.5 x 2.6") Weight 680 g (1.5 lb) Frequency Range 5.45 - 5.85 GHz Gain 10 dBi	Purchase	\$125	2018
		airMAX Sector Antenna AM- 5G19-120	AM-5G19-12 Dimensions (mm) 700 x 135 x 73 mm (27.6 x 5.3 x 2.9") Weight 5.9 kg (13 lb) Frequency Range 5.15 - 5.85 GHz Gain 18.6 - 19.1 dBi	Purchase	\$137	2023
		rocket 5AC PRISM	Rocket 5ac Prism Specifications Dimensions 88 x 40 x 230 mm (3.47 x 1.58 x 9.06") Weight 400 g (14.11 oz) Networking Interface (1) 10/100/1000 Ethernet Port RF Connectors (2) RP-SMA (Waterproof), (1) GPS* (Waterproof)	Purchase	\$250	2023
		rocket2AC PRISM	chrome- extension://efaidnbmnnnib pcajpcglclefindmkaj/https: //dl.ubnt.com/datasheets/R ocketAC/Rocket_R2AC_ DS.pdf	Purchase	\$250	2023
		BULLET AC	chrome- extension://efaidnbmnnnib pcajpcglclefindmkaj/https: //dl.ubnt.com/datasheets/b ullet_ac/Bullet_AC_DS.p df	Purchase	\$148	2022
Power System	ONBO	4s 7200mAh 50C LIPO Battery	Typical capacity : 5200mAh Typical Voltage: 14.8V Dimensions: 138mm x 47mm x 45mm Approx Weight:538g Continuous Discharge Current: 25C (130A)	Purchase	\$50	2022

	TATTU	6s 10000mAh 25C LiPo Battery	Capacity(mAh) 10000 Voltage(V) 22.2 Discharge Rate (C) 25 Max Burst discharge Rate (C) 50	Purchase	\$159	2022
Propulsion	Blue Robotics	T500	https://bluerobotics.com/store/thrusters/t100-t200-thrusters/t500-thruster/	Purchase	\$690.00	2022
	Blue Robotics	T200	https://bluerobotics.com/store/thrusters/t100-t200-thrusters/t200-thruster-r2-rp/	Purchase	\$200.00	2019
	Flipsky	Mini FSESC4.20 50A	Amps: 50A continuous,instantaneous current 150A Voltage: 8V-60V(Cells: 4-13S LiPo,Safe for 4S to 12S LiPo, Voltage spikes may not exceed 60V!) BEC: 5V@1.5A BEC type: Internal driver support	Purchase	\$85.00	2023
	SAVOX	SB-2290SG	Speed 7.4v - 0.13 sec/60 deg. Speed 8.4v - 0.11 sec/60 deg. Dimensions L x W x H (mm): 40.3 x 20.2 x 38.7. Weight: 8	Purchase	\$148.99	2022
Crane System	SAVOX	SW-0231MG	Torque 4.8v - 12.0kg/166.6oz-in Torque 6v -15.0kg/208.3oz-in Speed 4.8v - 0.20 sec/60 deg Speed 6v - 0.17 sec/60 deg Dimensions L x W x H (mm): 41.8 x 20.2 x 42.9 Weight: 66.0g1g.	Purchase	\$30	2023
	MRI	PG36 with encoder	PG36 75kg/fcm 63RPM, Voltage : 24Vdc, incremental encoder 7ppr, Reduction 1:188k	Borrowed		2023
		PG28 with encoder	max force :220 * 52 = 11.4kgfcm +- 15kgfcm max torque, Torque constant : 35*52=1.8kgfcm (+-) -> 2kgfcm .	Borrowed		2023
Cooling System	DELTA	Brushless fan	DELTA 9cm 12VDC 1,80A	Purchase	\$3.23	2023

	ASAIR	AHT10	Interface Type: I2C. Working voltage: 3.3~5.0 Vdc. Temperature: -40 Degrees C ~ 85 Degrees C. Humidity: 0~100%. Humidity accuracy: typical +- 2%.	Purchase	\$1.29	2023
LoRa system	MCUFRIE ND	2.4" TFT Display	2.4" diagonal LCD TFT display, 240×320 resolution, 5V compatible! Use with 3.3V or 5V logic	Purchase	\$6.13	2023
	LoRa	SX1278	LoRa ' Spread Spectrum modulation technology, Constant RF power output at + 20dBm-100mW voltage change, High sensitivity: down to -148dBm, Half-duplex SPI communication, Programmable bit rates up to 300kbps, Supports FSK, GFSK, MSK, GMSK, LoRa ' and OOK modulation modes	Purchase	\$6.07	2023
Water Pump (s)	-	DC 12 V Water Pump 8 - watt		Purchase	\$5.00	2023
LED Matrix		WS2812	Power Supply : DC 5V, SMD 5050 , IC WS2812, Non Waterproof IP20, Dobel tip : Yes	Purchase	\$7.49	2023
CANBUS	MRI	TJA1050	The DAPAT V2.0B support specifications include a communication rate of 1Mb/S. Data field ranges from 0 to 8 bytes.	Purchase	\$6.07	2023
Microcontroller	STM32	H755ZI	High-performance and DSP with DP-FPU, Arm Cortex-M7 + Cortex-M4 MCU with 2MBytes of Flash memory, 1MB RAM, 480 MHz CPU, Art Accelerator, L1 cache, external memory interface, large set of peripherals including a Crypto accelerator, SMPS	Purchase	\$31.37	2023
Ultrasonic	DFRobot	A02YYUW	3.3V-5V operating voltage range ,<8mA average	Purchase	\$21.47	2023

			current, 3cm blind zone distance, 3cm-450cm detecting range (flat object)			
Teleoperation	Radiolink	AT9sProR9DS	AT9S PRO 12 channels transmitter for racing drone, fixed wing, helicopter, glider, cars and boats (radiolink.com)	Purchase	\$170.00	2021
Waterproof Connectors		-	3P 20mm waterproof aviation Connector	Purchase	\$6	2023
Algorithms	Barunastra ITS	-		Custom	-	2023
Vision	OpenCV	-	YoloV7	Custom	-	2023
Open-Source Software	ROS2 BehaviorTree.CPP	-	-	Custom	-	2023
Autonomy	Barunastra ITS	-	-	Custom	-	2023
Localization and Mapping	Barunastra ITS	-	EKF	Custom	-	2023
Team Size	-	-	38	-	-	-
Testtime time: simulation	-	-	100 hours	-	-	-
Testing time: in-water	-	-	260 hours	-	-	-
Hardware/Software expertise ratio	-	-	3:1	-	-	-

APPENDIX C: NOZZLE TESTING PERFORMANCE

By using ANSYS fluent analysis we compared the velocity and pressure of nozzle in many size of diameter.

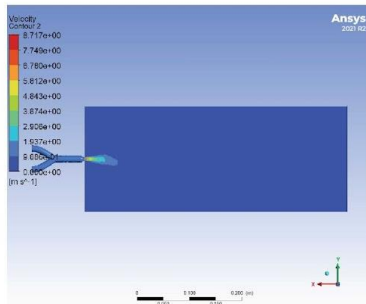

Diameter 0.5 cm

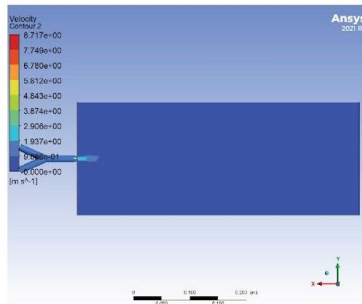

Diameter 0.8 cm

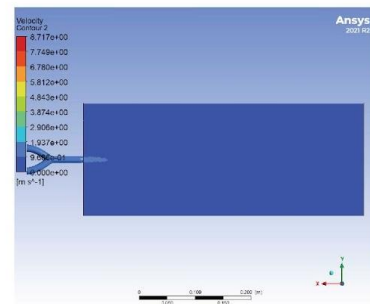

Diameter 1.0 cm

Using the data gathered from the ANSYS simulations, Barunastra ITS decided to use a water blaster nozzle diameter of 0.5cm.



APPENDIX D: ELECTRICAL COMMUNICATION ARCHITECTURE

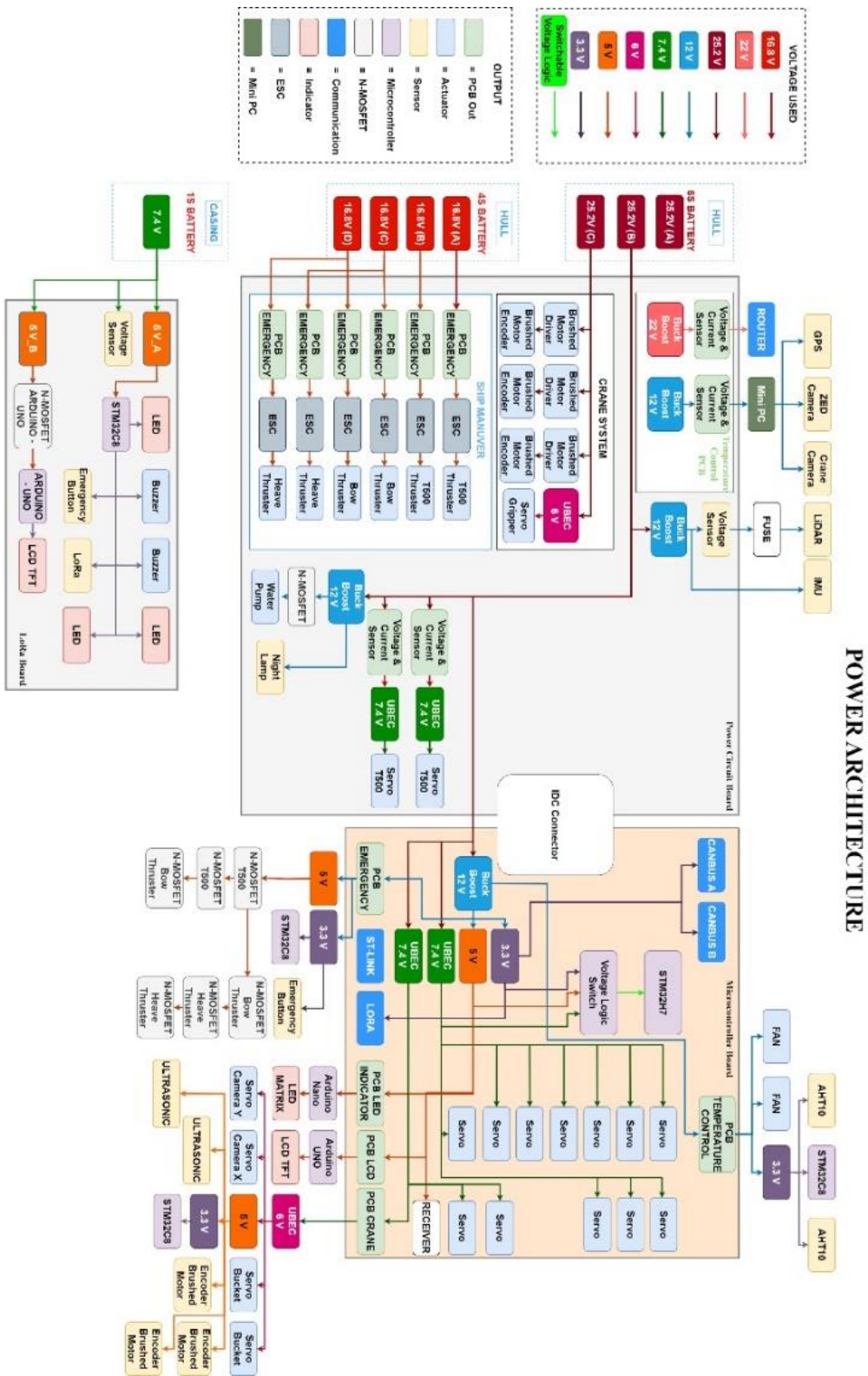

COMMUNICATION ARCHITECTURE

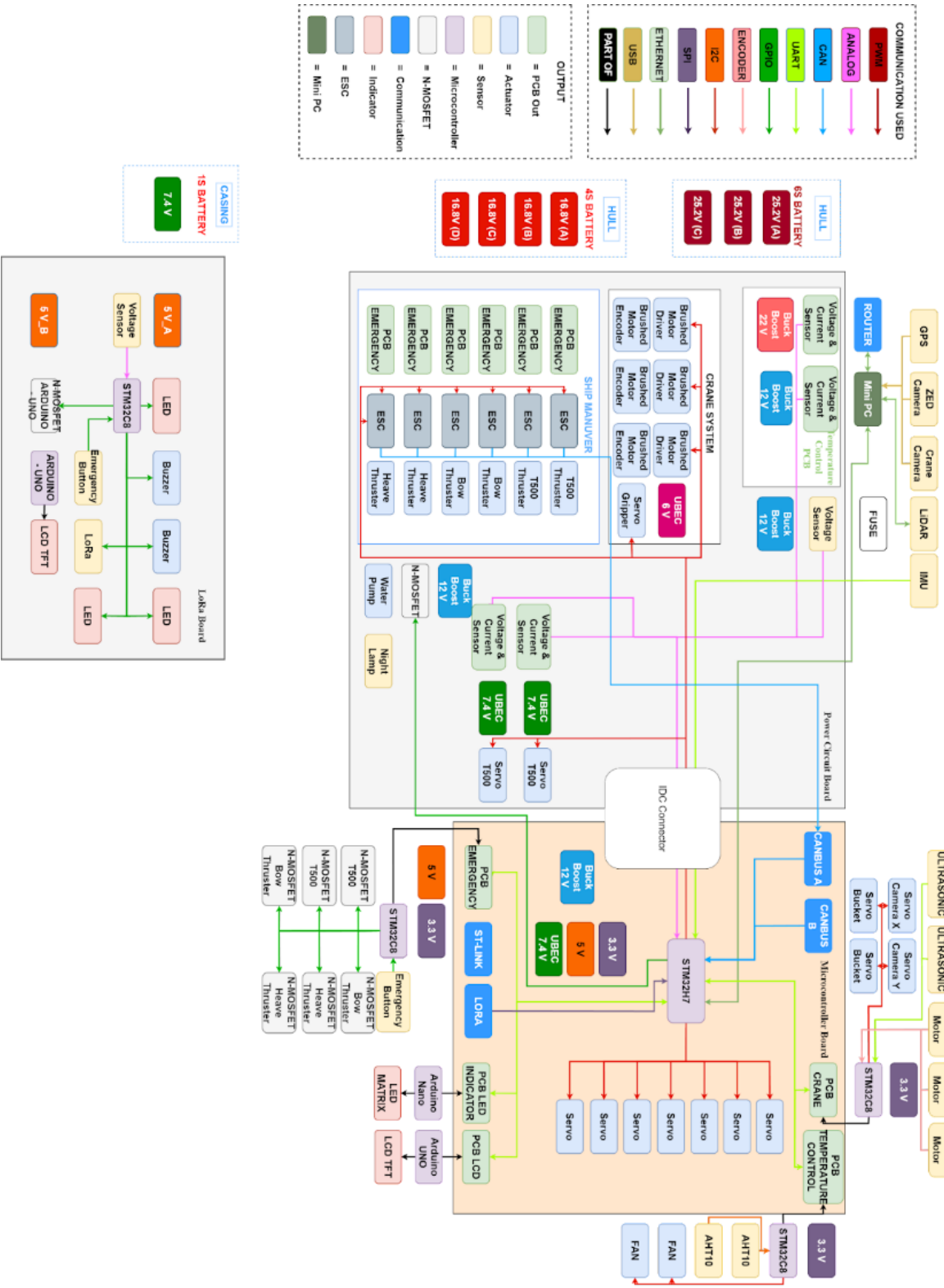

APPENDIX E : COMPUTER VISION INFERENCE AND METRICS

Inference using YOLOv7-tiny and ThunderSVM on NVIDIA RTX 2060.



YOLOv4-tiny-3l metrics.

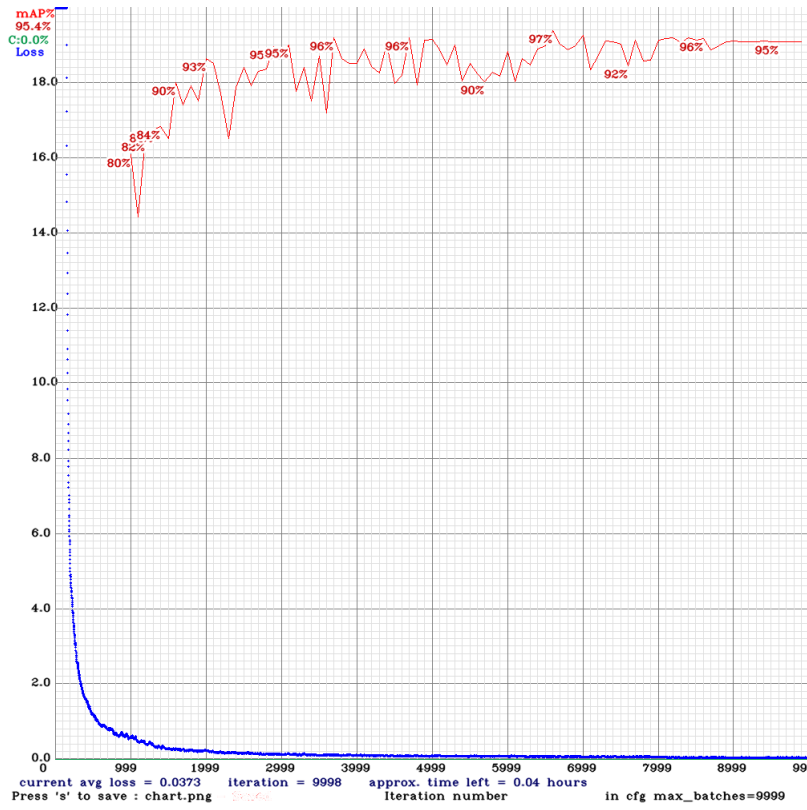

YOLOv7-tiny vs YOLOv7 metrics comparison using <https://wandb.ai>

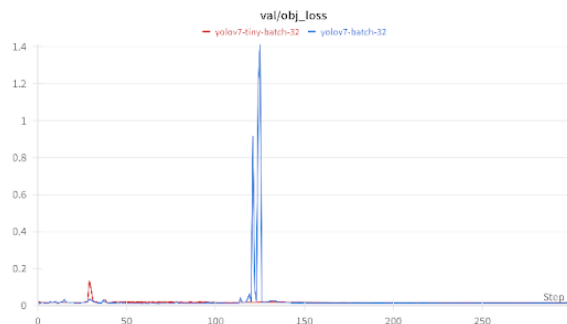
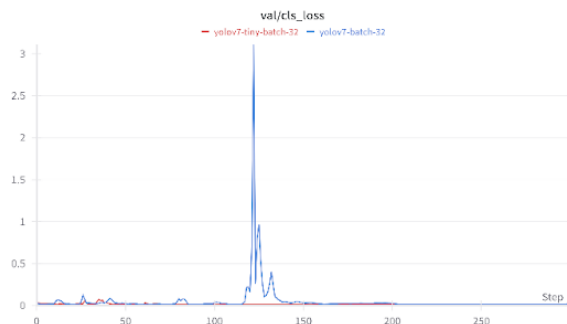
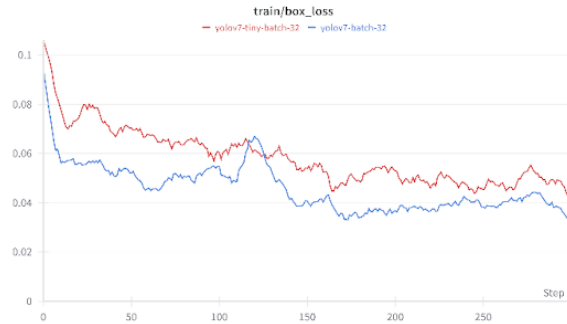
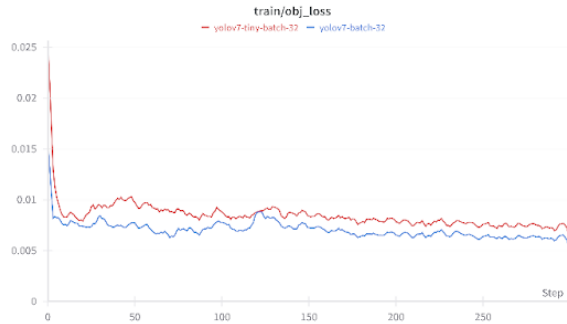
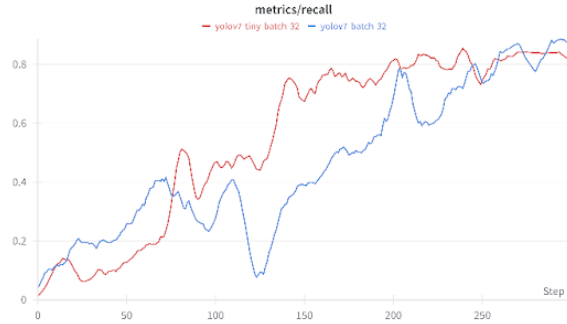
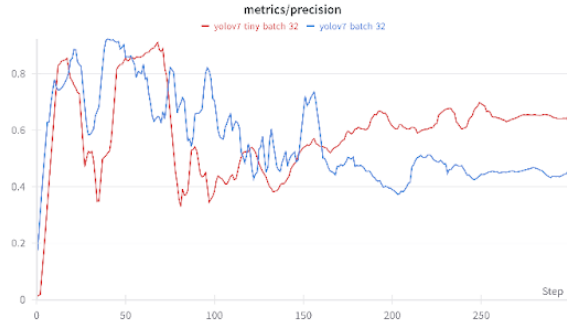
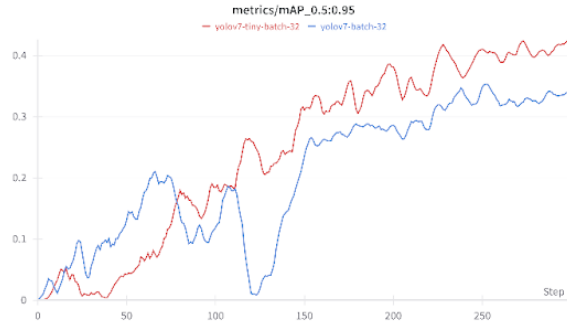
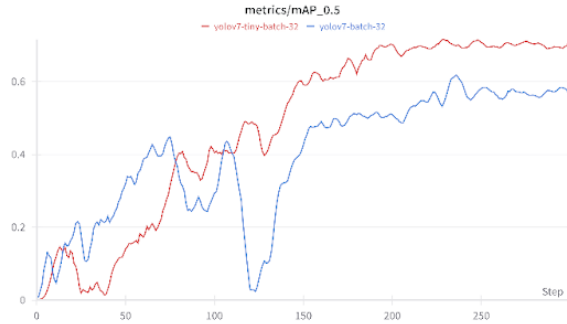

APPENDIX F: SPATIAL MAPPING SIMULATION

Spatial Mapping using ZED 2i Stereo Camera on NVIDIA RTX 2060.

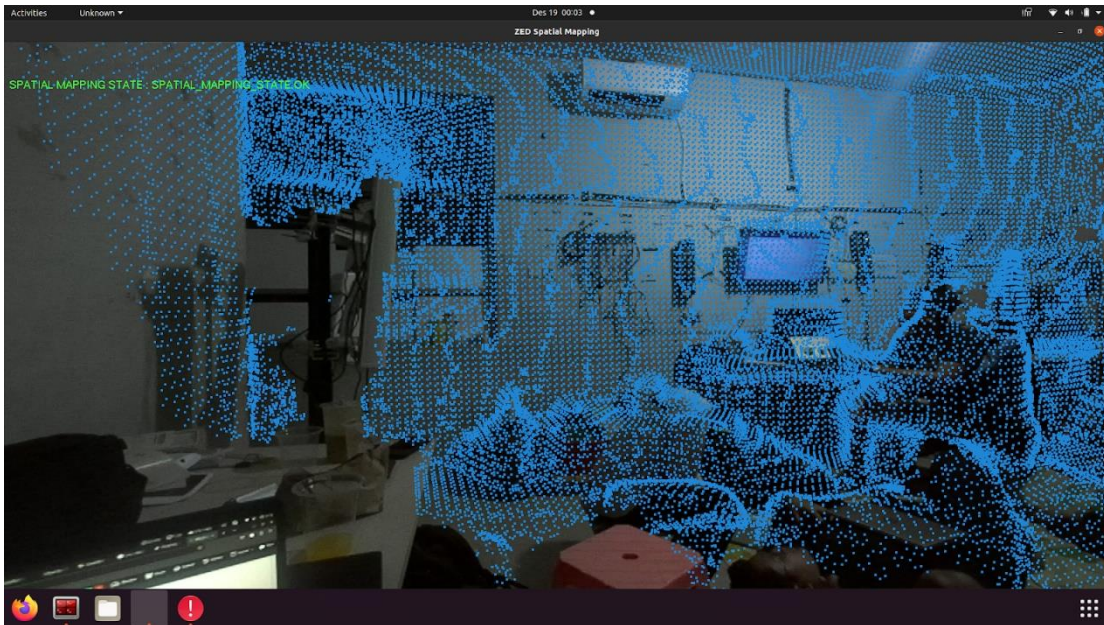

APPENDIX G: ROUTER TESTING

We conducted a series of experiments to measure the ping rate between two antennas. This is done using two frequency bands, each is tested in two conditions: clear and obstructed.



Below is given the relay data of an antenna during one of the test conditions (obstructed 5 GHz and 200 meter).

```
barun@barunastra: ~  
barun@barunastra:~$ ping 192.168.0.197  
PING 192.168.0.197 (192.168.0.197) 56(84) bytes of data:  
64 bytes from 192.168.0.197: icmp_seq=1 ttl=64 time=148 ms  
64 bytes from 192.168.0.197: icmp_seq=2 ttl=64 time=51.7 ms  
64 bytes from 192.168.0.197: icmp_seq=3 ttl=64 time=74.9 ms  
64 bytes from 192.168.0.197: icmp_seq=4 ttl=64 time=96.4 ms  
64 bytes from 192.168.0.197: icmp_seq=5 ttl=64 time=25.3 ms  
64 bytes from 192.168.0.197: icmp_seq=6 ttl=64 time=158 ms  
64 bytes from 192.168.0.197: icmp_seq=7 ttl=64 time=85.5 ms  
□
```

APPENDIX H: ON-WATER TEST PLAN AND RESULT

Date	Duration /day	Scope of Testing	Environment	Risk Management	Result
November 17-18, 2023	120 min.	<p>PROPULSION TEST</p> <p>- First test using Thruster + ESC T500 compared with Thruster + Flipsky VESC.</p>	Overcast, calm waters	The retaining ring was unable to be fastened onto the shaft, thereby risking disconnection of the propulsion arrangement.	<p>PROPULSION</p> <p>- Ship is able to surge, yaw, and sway well.</p> <p>- Thruster + Flipsky VESC is more responsive and can brake the thruster.</p>
		<p>SPEED TEST</p> <p>- Ship is operated at full speed moving in a straight line to assess the resulting wave and its velocity.</p>	Overcast, calm waters	Due to the high velocity, water may breach onboard.	- Ship experienced trim at high velocities due to great stern thruster torsion.
		<p>STABILITY TEST</p> <p>- Ship ran with varying movements (turning, zigzag, straight, holonomic)</p>	Overcast, calm waters	An iteration utilizing a new aluminum extrusion frame and connecting method risks detachment of Frame construction from the ship hull.	The ship can make varying movements.

November 24-25, 2023	90 min.	Adjustable Camera Angle Path following	Excessive heat	The camera cannot detect objects and the mini-PC is at risk of overheating.	<ul style="list-style-type: none">- Adjusted camera angle thanks to the addition of servo underneath; camera is fixed firmly to the servo.- Path following unable to be done because excessive heat made mini-PC overheating and malfunction.
December 1-2, 2023	150 min.	Autonomous Trial of New Board	Overcast, calm waters	Electrical board short circuiting	Ship can move following a predetermined GPS waypoint. Poor object detection due to dim lighting caused by the weather.

<p>December 8-9, 2023</p>	<p>120 min.</p>	<p>Completing them task using path following and object detection</p>	<p>Overcast, calm waters</p>	<p>Potential of malfunction due to electrical arrangements exposed to rain; loss of control.</p>	<ul style="list-style-type: none"> - Ship could not connect to the landbound laptop due to malfunction in the receiver's antennae. - Ship is capable of Navigation Channel, Follow The Path, Docking, and Speed Challenge.
<p>December 15-16, 2023</p>	<p>150 min.</p>	<p>Turning control and adjustable camera angle Task Duck Wash</p>	<p>Slight drizzle, overcast, and calm waters</p>	<p>Ship operating under unstable conditions with inaccurate tuning. Electrical components are at risk of short circuiting should they come in contact with water from the blaster.</p>	<ul style="list-style-type: none"> - Ship is successfully tuned to complete 5 tasks. - Ship can complete the duck wash task.